

“Grow and Know Your Food”
part of the
“Grow and Know with Montana Agriculture”
project.

Classroom gardening box assembly instructions.
(Read all of the pages before beginning.)

Materials List: Note: one 8ft 2x4 will provide enough wood for the project. It is not necessary to purchase cedar or redwood, but you may if you like!

2 - 18 inch pieces of 2x4

2 - 25.5 inch pieces of 2x4

8 - 2 inch drywall screws

1 piece (24” x 30”) heavy duty metal window screen or hardware cloth (wire mesh) to cover the bottom

Several old newspapers or a piece of landscape fabric to line the box

20 pound bag of potting mix (potting mix is easy to find, just check the bag)

4 - 5 packets of seed (lettuce, spinach, red beets, and radishes grow well in these boxes)

Cordless drill, hammer, and heavy duty stapler



Your finished box will look like this, see assembly instructions on following pages!

“Grow and Know Your Food” Assembly



Assembly Hint!

When you lay out the wood use this diagram for an example on how to fit the pieces together so that the **inside dimensions are 18" x 24"**.

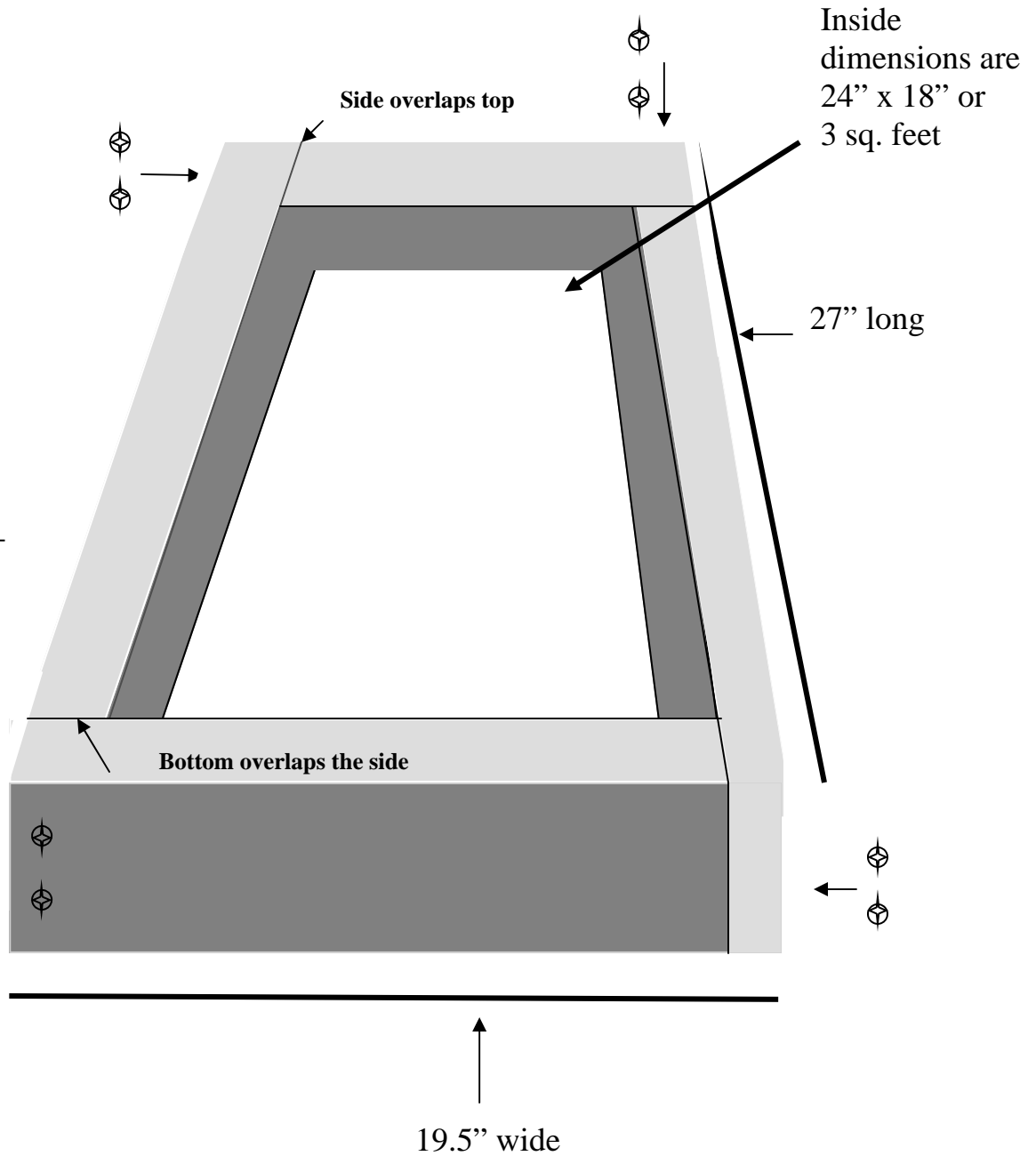
These dimensions work with our math lessons and give you a 3 sq. ft. interior. Note that the corners meet alternately for more strength. You can also add handles to the ends if you will need to move the box often.



KEY:



 Fasten with screws at these joints, it is a good idea to pre-drill the holes.

“Grow and Know Your Food” Attaching the bottom screen or hardware cloth (wire mesh)

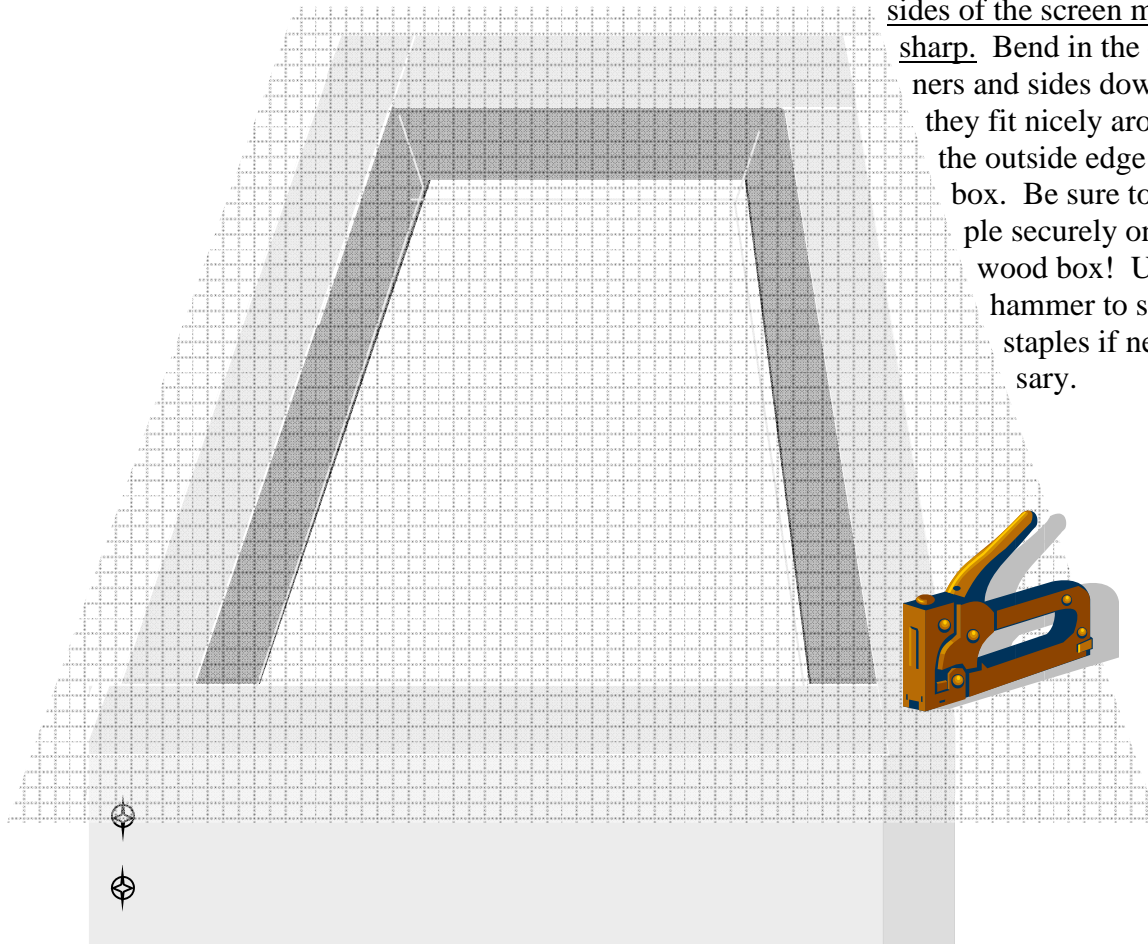
Decide which side you would like as the top and turn the box over so the bottom is up. Cover the bottom with the screen or hardware cloth, leaving about 1” hanging over the edge. Staple securely in place. Be careful, the sides of the screen may be sharp. Bend in the corners and sides down so they fit nicely around the outside edge of the box. Be sure to staple securely onto wood box! Use hammer to secure staples if necessary.

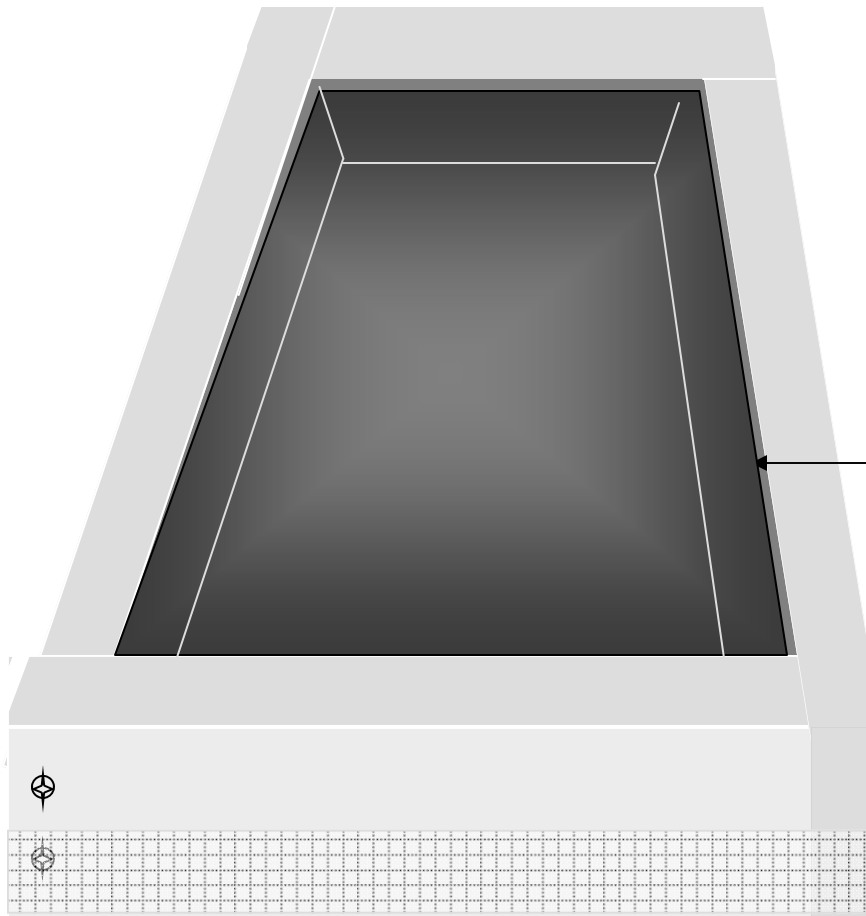

“Grow and Know Your Food” Lining the box



Turn the box over and line the box with 5-6 layers of newspaper or a layer of landscape fabric. Make sure the liner comes up to the top of the inside of the box.

Inside dimension is 24" x 18" or 3 sq. feet

“Grow and Know Your Food”
Add the potting mix

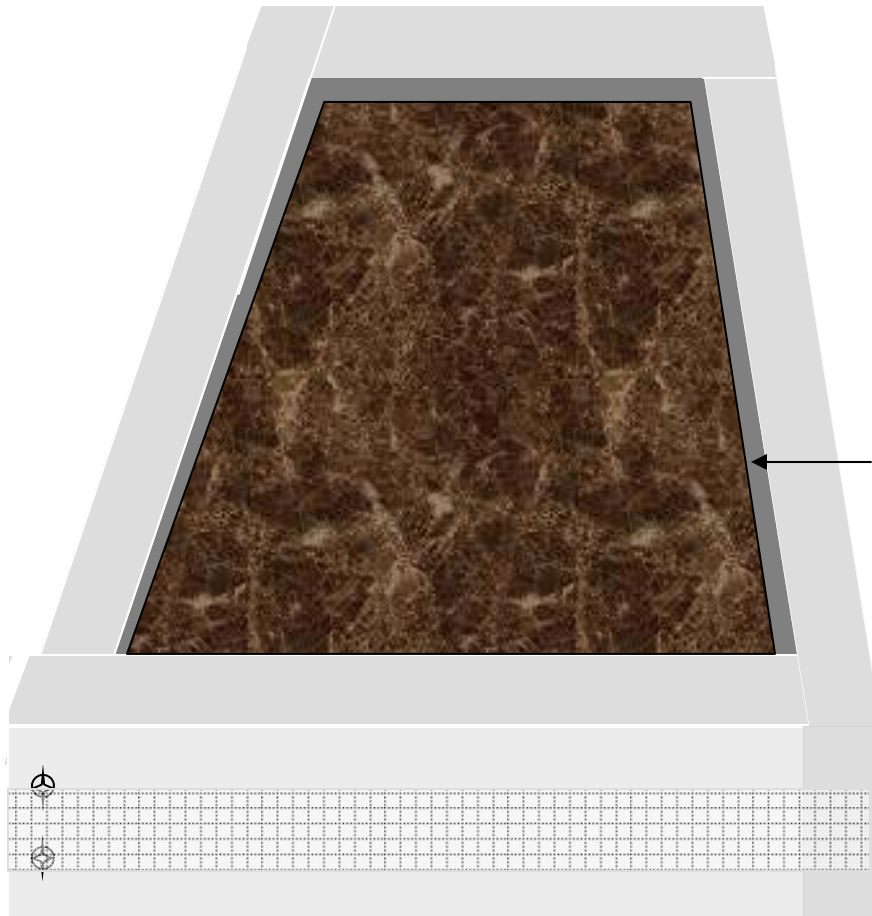

Fill to within 1/2 inch of top with pre-moistened potting mix.

Inside dimension is 24" x 18" or 3 sq. feet

“Grow and Know Your Food” Planting Directions



Follow planting directions on the back of the seed packets.

After planting, keep the soil moist by spritzing often with water! Make sure not to let the potting mix dry out.

Label each area with your seed packet.

Inside dimension is 24" x 18" or 3 sq. feet

“Grow and Know Your Food”

Caring for the garden

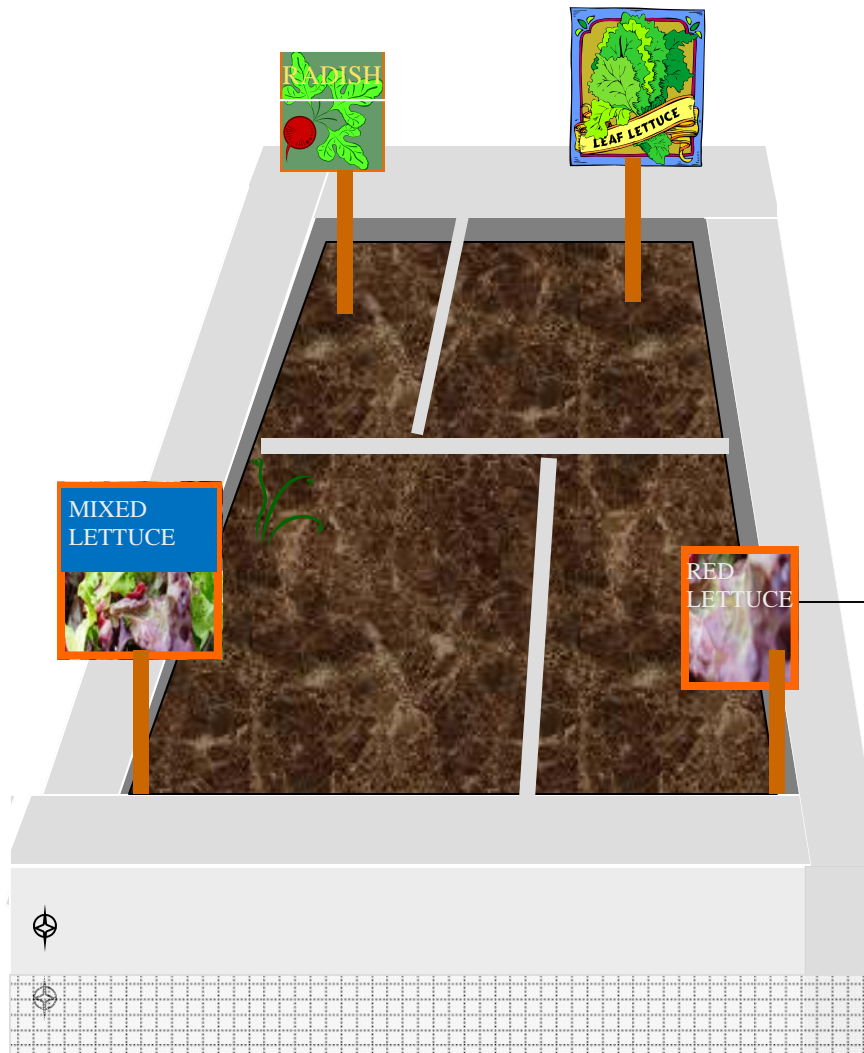

Inside dimension is 24” x 18” or 3 sq. feet

Your “Grow and Know Your Food” garden will only take minutes each day to check. Ask students to make a journal and write down their observations of what changes happen each day and explain the changes.

“Grow and Know Your Food” Growing Hints

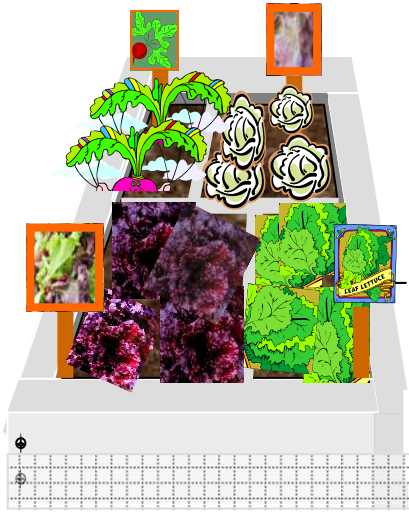

After the seedlings are about 1/2 inch tall you may begin watering the plants with a watering can. Be very careful not to wash away the plants or bend them over with the force of the water. Water lightly and check soil often, taking care not to overwater. A tray to catch any excess water can be used. A lid from a large storage container works well for a tray.

Make sure the box is near a sunny window or under a grow light.

Keep a record on the calendar of the number of days until the plants should be mature according to the seed packet.

Ask students to compare their journals to the seed packet information, what were their observations?

“Grow and Know Your Food”

Let us know about your classroom gardening experience!

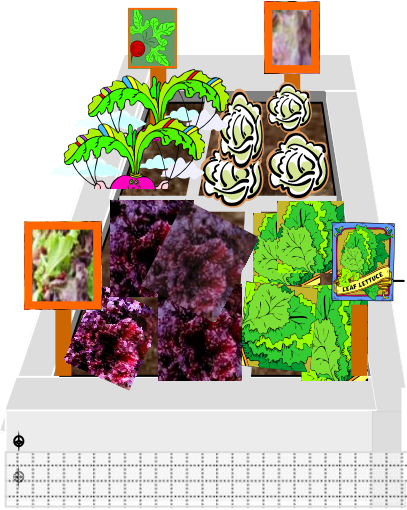

PLEASE SHARE GARDENING STORIES AND PICTURES WITH US BY
SENDING THEM TO: lbrenneman@mt.gov
WE WOULD LIKE TO INCLUDE THEM IN OUR NEWSLETTER AND ON
OUR WEBSITE, SO BE SURE TO HAVE PARENTAL PERMISSION FOR
THE STUDENTS TO BE PICTURED ON A PUBLIC WEBSITE.
WE HOPE YOU ENJOYED THIS LEARNING EXPERIENCE, CHECK OUT
MORE LESSONS AT:
<http://agr.mt.gov/agr/Programs/AgClassroom/>